

MAKE X

V2.0

机器人挑战赛

Robotics Competition

2024 - 2025

RULES GUIDE

MAKEX EXPLORER



2025.01

www.makex.cc/en



Date	Version	Modifications Record
2024.01	1.0	<p>MakeX Explorer Digital Pioneer Rules Guide First Publish.</p> <p>4.2 Arena</p> <ul style="list-style-type: none"> Optimized the illustration of the starting area <p>4.3 Props</p> <ul style="list-style-type: none"> Optimized the illustration and description of the Netflix Flag <p>4.4 Missions Introduction and Scoring State Judgement</p> <ul style="list-style-type: none"> Optimized "Mission Details" Optimized score state judgement for the Collecting Purification Cartridge mission Optimized score state judgement for the Upgrading Central purifier mission <p>4.6 Single Match Flow</p> <p>Optimized the process of "Manual Stage-Loading Flag"</p>
2024.07	1.1	<p>5.1 Robot General Specification</p> <ul style="list-style-type: none"> Optimized the description of "Robot General Spec." Optimized the description of motor and servo <p>5.2 Specifications for Netflix Flag</p> <ul style="list-style-type: none"> Optimized the illustration and description of Netflix Flag <p>6.2 Operation Rules</p> <ul style="list-style-type: none"> Optimized description and penalties for R10. Rules of Elimination Round Optimized description and penalties for R15. Manipulation violations during the automatic stage Delete "Contestant enter the arena in violation" Optimized description and penalties for R25. Violation Loading and Removal of the Robot Optimized description and penalties for R26. Prohibited to actively interfere opponents' robot hanging



<p>2024.09</p>	<p>1.2</p>	<p>4.3 List of props</p> <ul style="list-style-type: none"> Optimized the illustration and description of the Netflix Flag <p>4.4 Mission Introduction and Scoring State Judgement</p> <ul style="list-style-type: none"> Optimized the scoring judgement and related description of "Hanging Netflix Flag" Optimized the scoring judgement and related description of 'Upgrade Central Purifier'. <p>5.2 Specifications for Netflix Flag</p> <ul style="list-style-type: none"> Optimized the diagram and description of the Netflix Flag. <p>6.1 Penalty explanation</p> <ul style="list-style-type: none"> Add the description of 'Penalty Principles at Different Stages'. <p>6.2 Operation rules</p> <ul style="list-style-type: none"> R12 Optimized the description and penalties of "Operating the Robot in Advance". R18 Optimized the description of "Robot In-conformity during the competition". R20 Optimized the description for "Infield Toss and Move in Violation". R23 Optimized the description and penalties related to "Robot contact the central basket baffles in violation". R24&R25 Optimized the description and penalties relating to "Contestant Contact in violation". R26 Optimized the description and penalties relating to "Violation Loading and Removal of the Robot" R27&R28 Optimized the description and penalties relating to "Prohibition of Intentional Interference with the Opponent's Robot Hanging". <p>Updated Appendix 3 MakeX Explorer Digital Pioneer Robot Self-check Form.</p>
----------------	------------	---

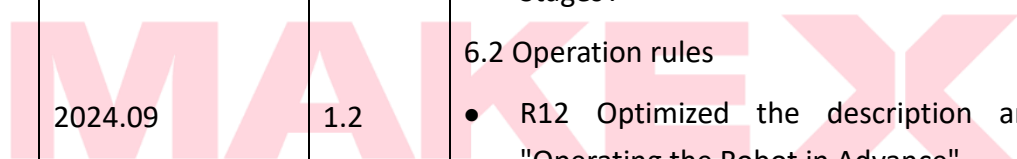



2025.01	2.0	<p>3. Competition Procedure</p> <ul style="list-style-type: none"> ● Optimized the description of “Robot Inspection” ● Optimized the description of “Engineering Notebook Submission” <p>4. Competition Details</p> <ul style="list-style-type: none"> ● Updated “Fig 4.1 Axonometric View of the Arena” ● Updated “Fig 4.2-1 Areas on the Competition Arena” ● Updated “Fig 4.2-2 Top View of Arena” ● Updated the description of the “Own resource area” and its figure. ● Updated the description of the “Network guardian barrier (cone hanging area)” and its figure ● Updated the description of the “Central reservation area” and its figure ● Updated the description of the “Props” and its figure ● Updated the description of “Missions Introduction and Scoring State Judgement” ● Optimized the description of “Referee's Scoring and Contestant's Results Confirmation” at “4.6 Single Match Flow” <p>5.1 Robot General Specification</p> <ul style="list-style-type: none"> ● Updated the description of “T08 Laser Sight” <p>5.2 Specifications for Netflix Flag</p> <ul style="list-style-type: none"> ● Updated the description of the “suspension components” <p>6.2 Operation Rules</p> <ul style="list-style-type: none"> ● Updated “Fig. 6.2-1 Contestant's Standing Position” ● Updated “Fig. 6.2-2 Robot Active Boundary” <p>7 Appeal and Arbitration</p> <ul style="list-style-type: none"> ● Optimized the description of “7.1 Results Confirmation” & “Appeal Procedure and Valid Appeal Period”
---------	-----	--



CONTENTS

- 1. Introduction1**
 - 1.1 About MakeX..... 1
 - 1.2 MakeX Spirit 1
 - 1.3 About MakeX Explorer..... 2
- 2. Competition Application.....3**
 - 2.1 Participation Requirements..... 3
 - 2.2 Registration and Application..... 3
- 3. Competition Procedure4**
- 4. Competition Details9**
 - 4.1 Introduction..... 10
 - 4.2 Arena..... 10
 - 4.3 Props 17
 - 4.4 Missions Introduction and Scoring State Judgement 19
 - 4.5 Scoring Explanation..... 26
 - 4.6 Single Match Flow 27
- 5. Technical Specifications29**
 - 5.1 Robot General Specification..... 29
 - 5.2 Specifications for Netflix Flag..... 35
- 6. Competition Rules.....37**
 - 6.1 Penalty Explanation 37
 - 6.2 Operation Rules 38
- 7. Appeal and Arbitration.....49**
 - 7.1 Results Confirmation 49
 - 7.2 Appeal Procedure and Valid Appeal Period..... 50
 - 7.3 Invalid Appeal 50





7.4 Arbitration Procedure..... 51

8. Statement..... 52

8.1 Rules Explanation 52

8.2 Disclaimer 53

8.3 Copyright Declaration 54

Appendix 1. Awards and Annual Points 54

Appendix 2. Engineering Notebook Guideline..... 57

Appendix 3. Robot Self-Check Form..... 59

Appendix 4. MakeX Explorer Digital Pioneer Score Sheet..... 62

Appendix 5. Competition Resources 63





1. Introduction

1.1 About MakeX

MakeX is an international robotics competition and education platform that promotes multidisciplinary learning within the fields of science and technology. It aims at building a world where STEAM education is highly appreciated and where young people are passionate about innovation by engaging them in exciting Robotics Competition, STEAM Carnival, Tech Event, Educational Conference etc.

As the core activity of MakeX, the namesake MakeX Robotics Competition provides exciting, challenging and high-level competitions in the spirit of creativity, teamwork, fun and sharing. It is committed to inspiring young people to learn Science (S), Technology (T), Engineering (E), Art (A) and Mathematics (M) and apply such knowledge in solving real-world problems.

1.2 MakeX Spirit

Creativity: we advocate curiousness and innovation, encouraging all contestants to create unique high-tech works with their talent, and challenge themselves for continuous progress!

Teamwork: we advocate solidarity and friendship, encouraging all contestants to develop a sense of responsibility and enterprising spirit, and sincerely working with their partners for win-win development!

Fun: we encourage contestants to build a positive, healthy mindset in the competition. Enjoy the journey and grow in the process.

Sharing: we encourage contestants to have an open mind as a maker and share their knowledge, responsibility, and joy with everyone, including their teammates and competitors.

MakeX spirit is the cultural cornerstone of the MakeX Robotics Competition. We



hope to provide a platform for all contestants, mentors and industry experts to exchange ideas, study and grow up, and help young people acquire new skills during creation, learn to respect others in teamwork, gain an enjoyable life experience in the competition, take delight in sharing with the society their knowledge and responsibility, and work hard to achieve their grand aspiration of changing the world and creating the future !

1.3 About MakeX Explorer

MakeX Explorer is a confrontational competition program for elementary and junior high school students aged 8-15.

This program fully integrates the essence of sports events and is highly interesting and a delight to watch. The competition requires the contestants to design and build robots from scratch, which systematically develops the contestants' comprehensive abilities in robot design, mechanical construction, and programming. Also, the form of alliance confrontation improves the contestants' ability to solve imperative problems and develop strategic thinking.



2. Competition Application

2.1 Participation Requirements

Participants: Contestants shall participate in teams, the number of contestants is 2-4 for each team, with 1-2 mentor(s).

Age: Team members must be between the age of 8-15 (born between January 2, 2009 and December 31, 2017). The mentor must be at least 18 years old.

Team Roles: Everyone in the team can play their respective roles as operator, observer, mechanist, programmer and so on. In each match, one team can only appoint 1 operator and 1 observer to participate, only two team members are allowed to compete in the competing area. The operator is responsible for operating the robot, and the observer is responsible for assisting the operator in observing the status of props and making suggestions.

Identification Symbols: Each team must have a team logo, team name, and team slogan. Teams are encouraged to use uniforms, flags, posters, badges, base decorations, etc. to show the team culture.

2.2 Registration and Application

Contestants and mentors who meet participation requirements can register on the designated competition web page on the MakeX official website (www.makex.cc/en). Each team should register with one registration form.

If the participating team wants to change their members before the competition, which leads to inconsistency with the registration information, they should inform the MakeX Robotics Competition Committee in advance to finish re-registration.

For more details about the registration and application, please refer to [MakeX Registration & Competition Application Guide](#)

3. Competition Procedure

Participating teams shall pay close attention to related notices and the Competition Guide published before each competition. If the rules have some updates in the competition guide, the latest rules will be adopted for the competition. MakeX Competition Committee reserves the rights and final interpretation to amend competition rules and systems based on the actual situation of different competitions.

The schedule for each competition is determined by the actual situation and generally includes the following procedures.

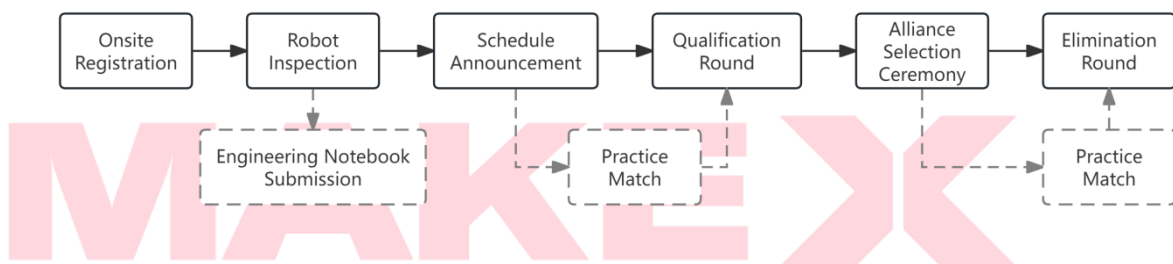

* Note: The solid line frame refers to the necessary procedure of each match, while the dotted line frame refers to the non-essential procedure. Please keep abreast of updates.

Onsite Registration

When a team arrives at the venue, mentors and contestants should show ID cards or other valid certificates (e.g., passport) for onsite registration and to get the competition pack. Mentors must inform team members about the fire exit, match schedule, arena, pits area, etc. Onsite registration and robot inspection will be closed once the match schedule is announced.

Robot Inspection

Teams are required to check their robots and team markers before the competition and complete the "**Appendix 3: Robot Self-Inspection Form**" according to the actual data. Teams are required to check their robot against the Self-Inspection items to make sure it meets the requirements associated with robot construction. During the



robot inspection time, the inspectors will randomly check the robot and team markers against the completed Robot Self-Inspection Form. Teams that do not provide the completed Robot Self-Inspection Form will not be accepted for inspection; For teams that provide complete inspection materials, the inspector will stick the inspection sticker of the match to the robot, and the inspection sticker can not be removed after sticking, if there is any special reason that causes the inspection sticker to be broken, please take the initiative to communicate with the organizing committee and explain the reason.

Before the official match, participating teams are obligated to conduct self-inspections on their robots and mutual inspections on the opposing robots, and make necessary corrections promptly before entering the arena.

Once in the arena, malicious complaints are not allowed (for the definition of malicious complaints, please refer to section 6.2 Operational Rules - R31). Teams must follow the referee's instructions and raise their hands to confirm that both robots are correct before the match begins. After this point, unless filing a complaint, no further on-site inspections of the robots are allowed.

Schedule Announcement

The committee will announce the match schedule at least 30 minutes ahead of the competition through the online official website and onsite announcement. The schedule includes a match-up chart, match session and specific time, red alliance and blue alliance, etc. If the two matches are too closed, please sign up at the Result Approval Area.

Engineering Notebook Submission

Each team is required to submit 1 paper copy of their team's engineering notebook to the MakeX staff. If you are unable to submit the original version, please prepare your own copy. The engineering notebook will be used as an important basis for the selection of the special awards, teams that do not submit engineering notebooks are by default excluded from engineering notebook-related awards. The paper version of the engineering notes will not be returned after submission. For suggestions on how



to write the engineering notes, please refer to "**Appendix 2: Engineering notebook guideline**". Not all competitions will include engineering notebook-related award selection. Please refer to the content of the Competition Guide distributed before the competition for the awards.

Practice Round

Teams who have finished their robot inspection can participate in the practice round. The schedule will be announced at the entrance in the form of notices, and teams are required to queue in line before entrance. Not all competitions have a practice round, which can be informed based on the actual situation.

Waiting for the match

During the regular competition, the venue will be equipped with a waiting area and Make staff will announce or post the number of waiting matches in the pits area. Participating teams should pay attention to the notification of waiting matches and go to the corresponding waiting area according to the notified waiting matches.

Qualification Round

Normally, each team is requested to participate in four matches during the qualification round. However, the session of the qualification round may be different based on different competitions. In the qualification round, the red alliance and blue alliance are matched randomly. Points will be obtained by teams according to the winning or losing result. It is conducted in the form of alliance confrontation and each team's alliance and the opponents will be allocated randomly.

In each qualification round, all teams will receive corresponding points (including win, tie, and loss) regardless of competition type. Three points for a win, one point for a tie, and no point for a loss. The final ranking is based on the sum of win-loss points of all qualification rounds, and the top-ranking teams will be promoted to the Elimination round.

If the teams with the same win-loss points, the ranking sequence will be determined according to the following rules:



- 1) The team with a higher total points differential of all qualification rounds has a higher ranking.
- 2) If the above conditions are the same, the team with higher total scores among all qualification rounds has a higher ranking.
- 3) If the above conditions are the same, the team with the highest score of a single round in all qualification rounds has a higher ranking.
- 4) If the above conditions are the same, teams with the same ranking will play a one-on-one extra match, and those with the highest total points will be the winner.

Alliance Selection Ceremony

In the alliance selection ceremony, promoted teams will select their alliance team in turn according to their ranking in the qualification round. Alliances that are generated after the ceremony will be the alliances for the elimination round. The alliances will be named "Alliance 1", "Alliance 2", Alliance 3" and so on according to the generated sequence. During this procedure, teams must abide by the following rules (For point races only, other levels of competition are subject to pre-match announcements):

Teams ranked in the top 50% have the right of refusal once, the first time the team is chosen, the team can refuse, the right of refusal will automatically expire after using it once, teams ranked in the bottom 50% have no right of refusal when they are chosen, and when refused by the chosen team, the team can continue to choose their next alliance teammate until the alliance is formed.

The promoted teams who are not present before the start of alliance selection are deemed as voluntarily giving up the right to choose an alliance, and those who are not present until the end of the alliance selection are considered to be as voluntarily quitting the elimination round. If the promoted teams quit amid the alliance selection ceremony, the promotion places will be given to the following teams according to the ranking in the qualification round.

During the alliance selection ceremony, each team representative will have 30



seconds to make their decision when it is their turn, and if they are not selected within the 30-second time limit, they will lose the right to select and will move on to the next team in order.

The promotion proportion for the 2024-2025 season competition is as follows. However, the promotion quota in different competitions may be different according to the actual situation.

Number of participating teams	Number of promoted teams
97 and more	64
49-96	32
25-48	16
12-24	8

Elimination Round

During the elimination round, the alliances generated in the alliance selection ceremony will be the opponent (red alliance and blue alliance are automatically matched) according to the competition schedule. The winner will be evaluated by BO3(Best of 3) and the alliance that achieves "two wins" or "one win and two ties" can advance to the next round until the champion, runner-up and second runner-up are elected.

If the two alliances achieve "1 win, 1 loss, 1 tie" or "3 ties" in a BO3, the winning alliance will be decided according to the following rules:

- 1) If win-loss points are the same, the alliance with a higher total point differential in BO3 has a higher ranking.
- 2) If the above conditions are the same, the alliance with the highest scores in BO3 has a higher ranking.
- 3) If the above conditions are the same, alliances will play an extra match until the winner is elected.



Taking the promoted 32 teams as an example, the schedule of the elimination round is as follows:

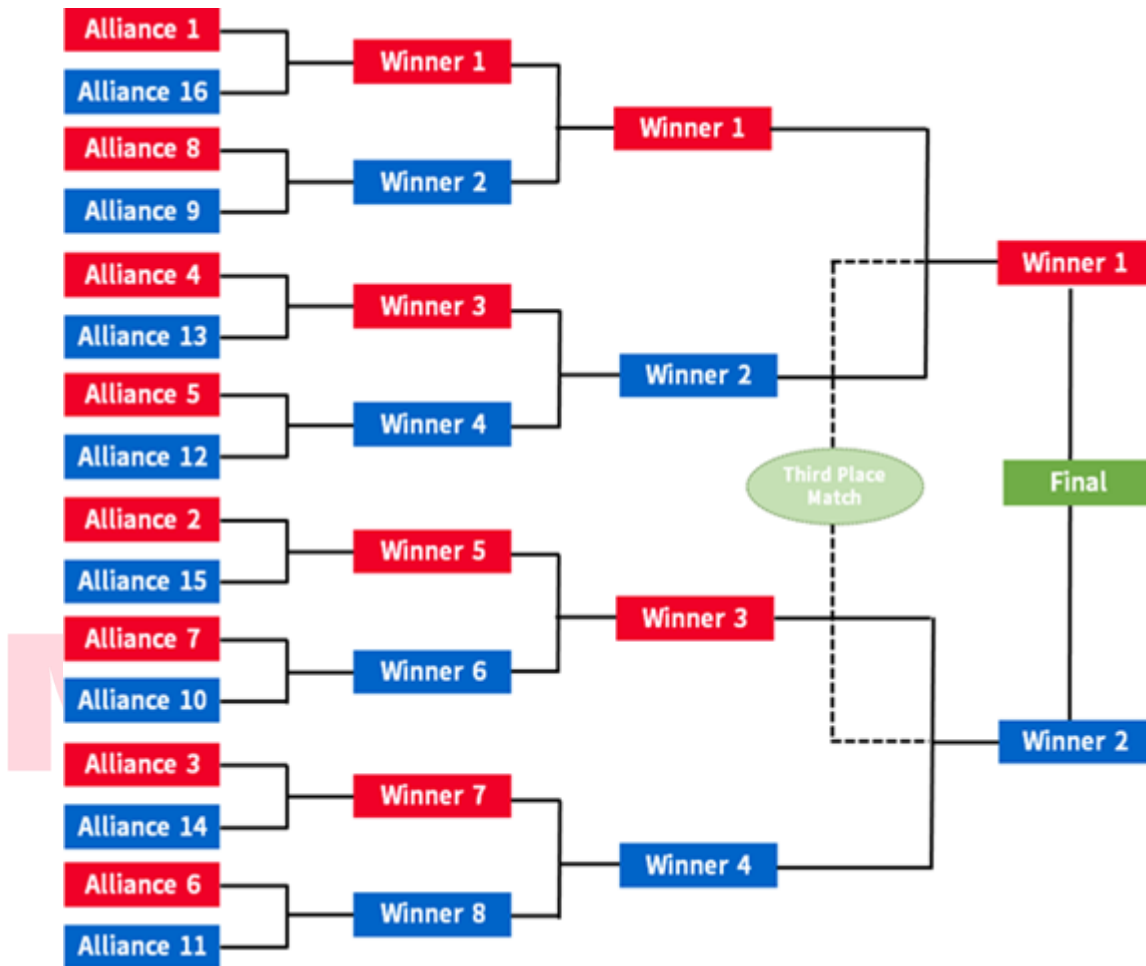

4. Competition Details

The theme of the 2024-2025 Season MakeX Explorer is "Digital Pioneer".

Computer algorithm is one of the core technologies of artificial intelligence, which is extended through algorithms to computer vision, voice recognition, big data processing, robotics and other fields. In the brand-new confrontation, facing the boundless map, unknown opponents, and heavy hurdles, the teenager skillfully uses computer algorithms to break through and step by step fight against cyber fraud and cybercrime, purify the cyber world, and create a clean and orderly cyberspace.



4.1 Introduction

MakeX Explorer is a confrontational competition, among which red and blue alliances for each match, and two teams for each alliance.

Each match comprises an automatic stage and a manual stage. Teams are required to control the robot to finish missions automatically or manually. At the end of the competition, the referee will calculate all of the mission points for both teams, and the alliance with the higher score will be the winner.

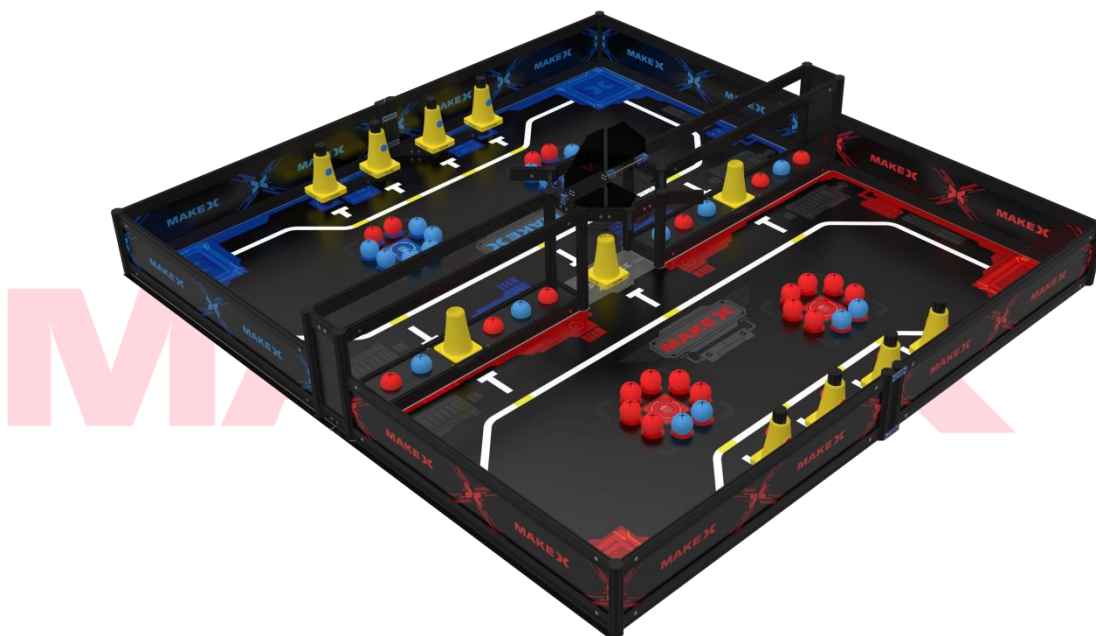

Fig 4.1 Axonometric View of the Arena

4.2 Arena

The arena of MakeX Explorer is composed of a map and frame. The arena is rectangular with a size of 2532 mm * 2426 mm, and the map size is 2443 mm * 2215 mm, the border around the frame is 255mm in height and 15mm in thickness. The arena mainly consists of the starting area, its own resource area, network guardian barrier (cone hanging area) and the central reservation area that consists of a central resource area, the internet garbage collector (centre basket), flag hanging area and central purifier (robot hanging area). Some matches may have a competition box that



displays the match time in real time.



Fig 4.2-1 Areas on the Competition Arena

The competition arena is divided into red camp, blue camp and central area. Robots are only allowed to finish corresponding missions in individual camps.

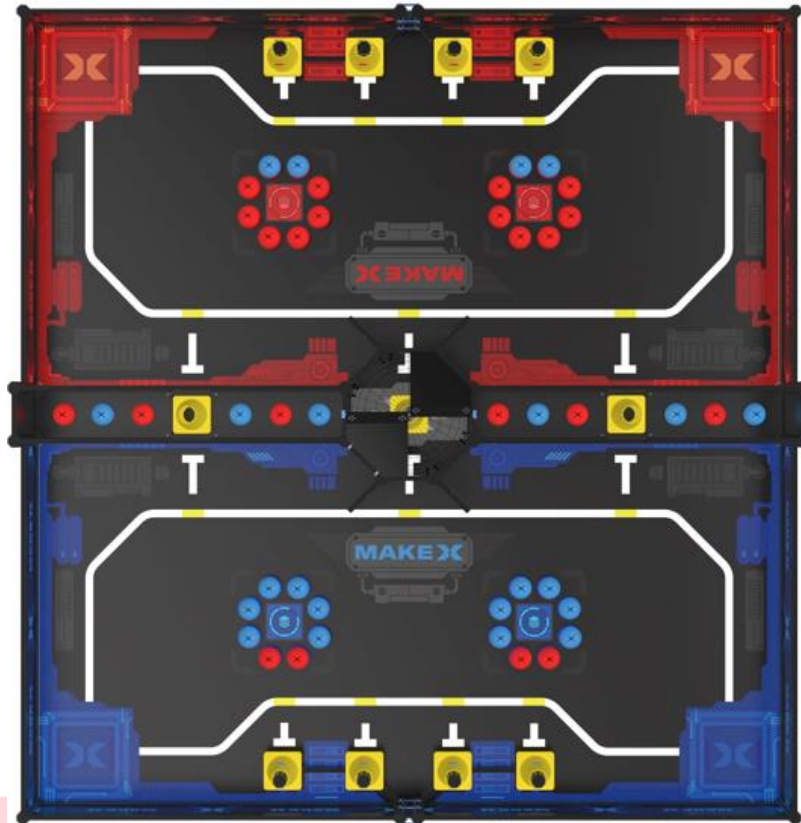

Fig 4.2-2 Top View of Arena

Starting Area

With the size of 320mm * 320mm, the starting area, located at the four corners of the arena, is where robots are placed before the competition. There are two starting areas for the red alliance and the blue alliance.

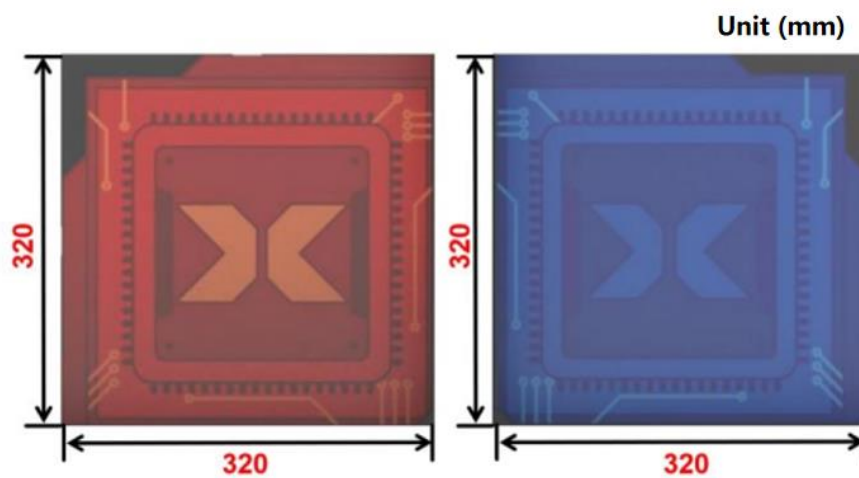

Fig 4.2-3 The Starting Area



Own resource area

Own resource areas are located on the respective camp of the arena. There are 2 resource areas for each of the red and blue camps, for a total of 4 in the arena; each own resource area contains Purification Cartridges (balls), including Privacy Cartridges (Red Balls) and Rumor Cleansing Cartridges (Blue Balls); each own resource area contains 6 balls of own side's color and 2 balls of the opponent's color; there are 12 balls of own side's color, and 4 balls of the opponent's color in the respective camps.



Fig 4.2-4 The own resource area

Network guardian barrier (cone hanging area)

Each red and blue camp has one network guardian barrier (cone hanging area), and the cone hanging bars are in contact with the ground and the map, located at the back of each camp. It comprises the 220mm flat beam, 120mm flat beam and 250mm octagonal pillar.



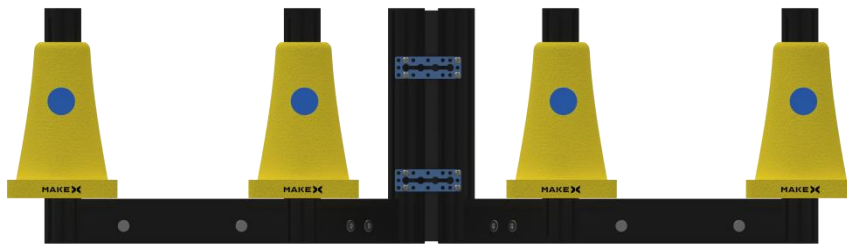

Fig 4.2-5 Cone Hanging Area

Central reservation area

There is one central reservation area in the arena, including 4 parts, the central resource area, the network garbage collector (centre basket), the central purifier (robot hanging poles area) and the flag hanging area. The dimension of the central reservation area is: 2428mm*200mm*580mm.

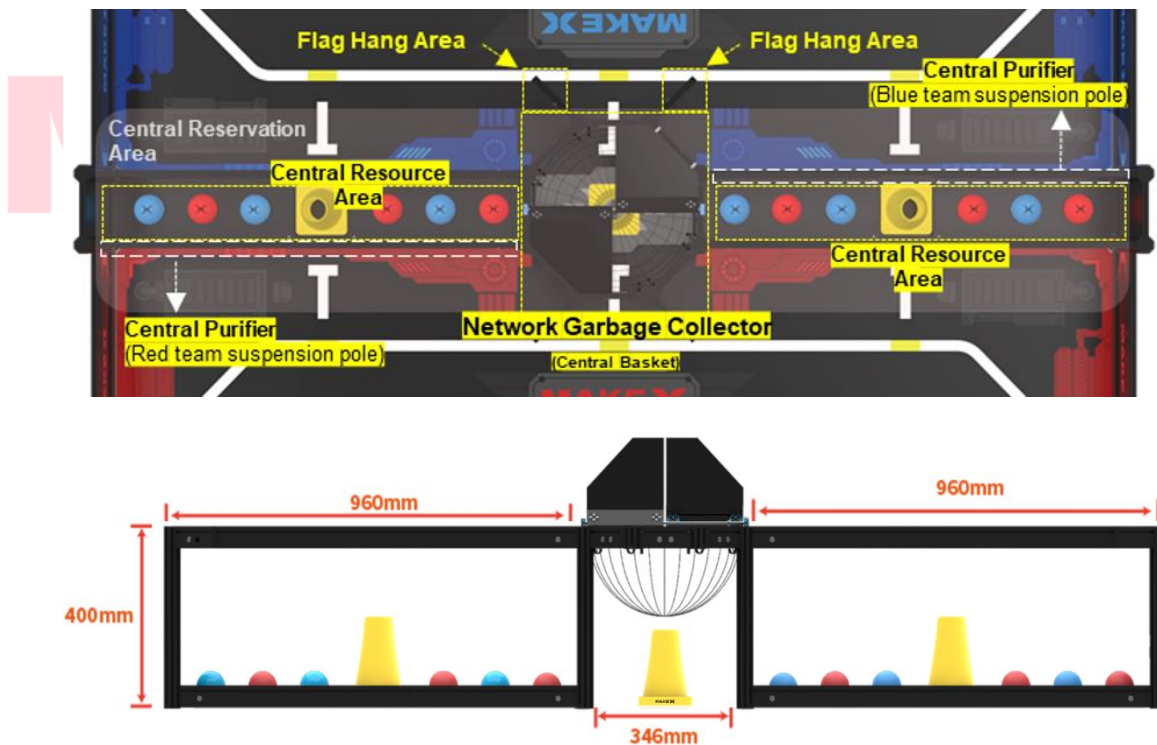

Fig 4.2-6 Central Reservation Area

The central resource area is located on both sides of the central basket, consisting of 960mm, 120mm flat beams and 400mm octagonal pillar with dimensions of 960mm*120mm*400mm; the purification cartridges (balls) and network waste catchers (cones) are placed on both sides.

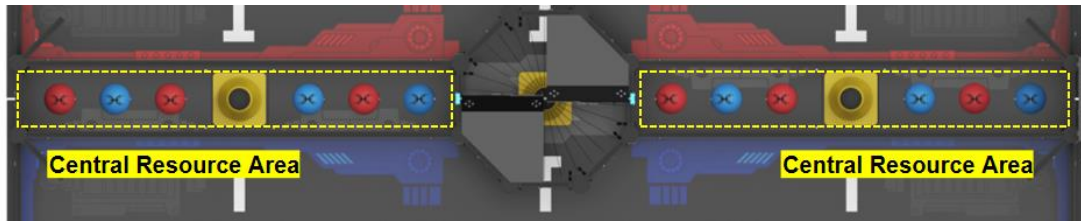

Fig 4.2-7 Central Resource Area

The network garbage collector (central basket) is located in the centre of the arena and consists of an octagonal shape made of 120mm flat beams and octagonal pillars, with an internal diameter of 370mm, an overall height of 600mm, the height of the basket is 400mm, and two reversible baffles on top of the basket, with the height of 200mm. By default, the left side of the central basket occupied by each party is pressed down and the right side of the basket is upright as the initial state of the area.

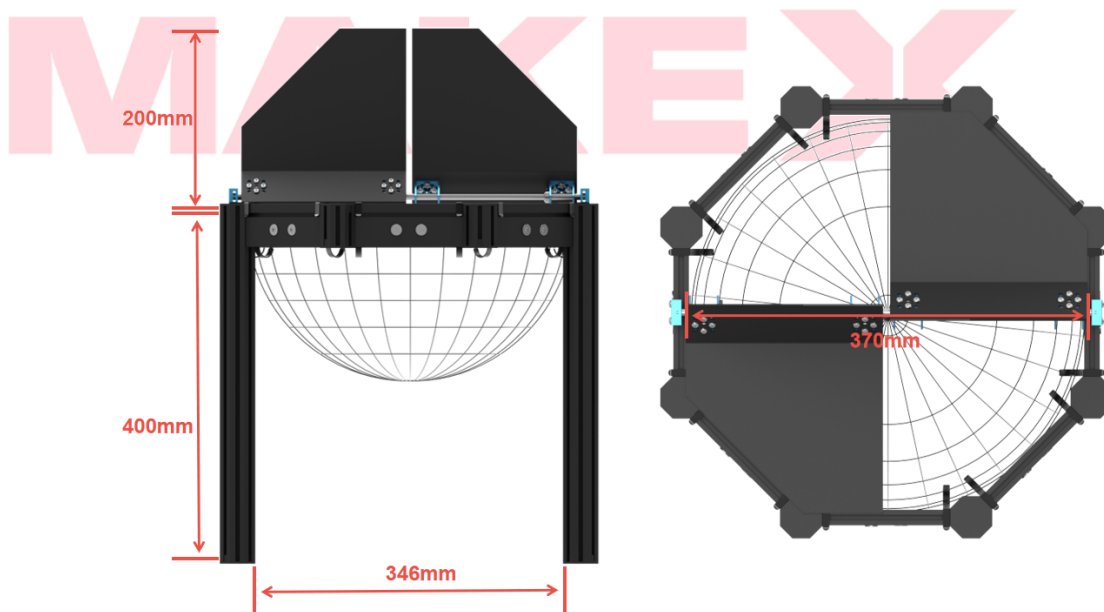

Fig 4.2-8 Central Basket

There are 4 central purifiers (suspension poles) in the arena, 2 for each of the red and blue camps, consisting of 960mm flat beams "hanging poles" whose highest point size is: 400mm;

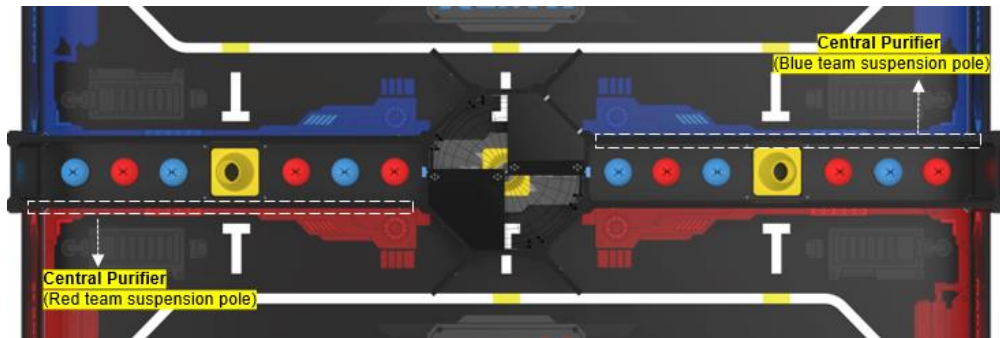

Fig 4.2-9 Robot hanging area

Flag hanging area

There are 2 symmetrical flag-hanging devices on each side of the field, each connected to the apex of the octagonal pillar of the central basket parallel to the letters MAKEX on the map, for a total of 4 flag-hanging areas on the field, with a horizontal flat aluminum length of 120mm, which is used to hang the team's flags.

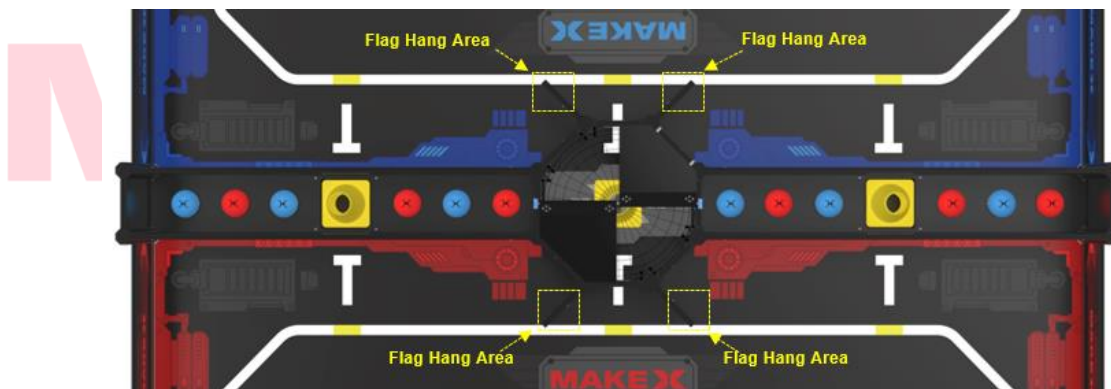

Fig 4.2-10 Flag hanging area

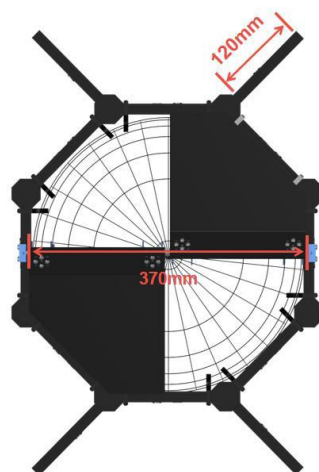

Fig 4.2-11 Flag hanging area

4.3 Props

Purification Cartridges (Balls)

Purification Cartridges are the red and blue balls on the arena, initially placed in the central resource area and the own resource area.

Material: EVA;

Size: Red/Blue balls are 70mm in diameter;

Quantity: There are in total of 44 red/blue balls on the arena, 22 in each of red/blue balls. Among them, there are 16 balls in each of the red and blue side resource area, and 12 balls in the central resource area;

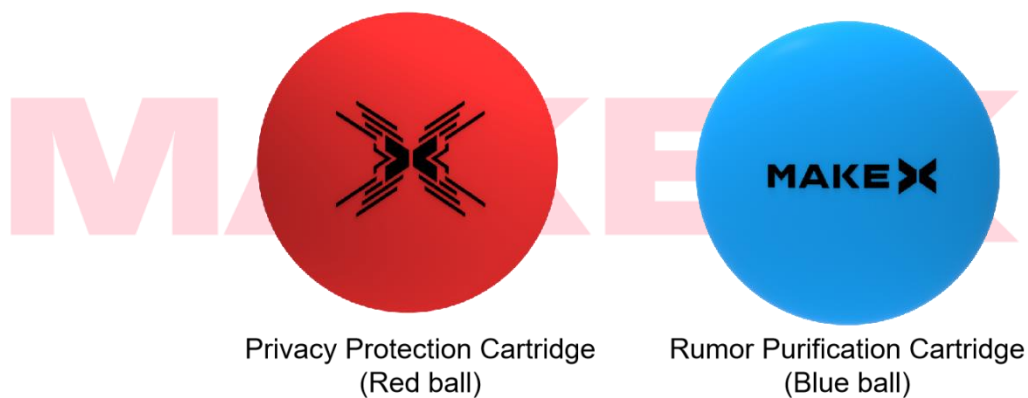

Fig 4.3-1 Purification Cartridges (Balls)

Network spam catcher (Cone)

The network spam catcher is the yellow cone, initially placed in the central resource placement area and the cone hanging areas.

Material: EVA; Size: Base size is 120mm*120mm*20mm, overall height is 170mm;

Quantity: There are 11 cones in the whole arena, among four red dot cones hanging on the red cone hanging area, four blue dot cones hanging on the blue cone hanging area, and a total of three in the central resource area; no cones are placed in the cone placement area of the own resource area during the initial setup of the arena.



Fig 4.3-2 Network spam catcher (Cone)

Netflix Flag (Self-made prop)

The Netflix flag must be made by the team itself, and each team is only allowed to use one flag. The team flag must consist of a flag surface and suspension components, and the flag structure must follow the regular flag shape, with no irregular flag shapes permitted, as shown in diagrams 4.3-3.

Flag Surface Requirements: The flag surface must be made of flexible materials, such as fabric, paper, or other flexible materials. The flag surface must be a rectangular whole flag, with each side measuring no less than 150mm, and cannot be cut or shaped irregularly. The content of the flag must include the "team name," and the team name must be the official name of the competing team. No other team names may be marked or used on the flag.

Suspension Component Requirements: If a flagpole is used, it can be made of rigid materials, and the length of the flagpole must be equal to the length of the side to which the flag is attached. The cross-section of the flagpole must be smaller than 10mm x 10mm. Irregular flagpoles or adding unusual weights to the suspension components are not allowed. Otherwise, the self-made prop will be considered non-compliant and invalid for scoring.

The committee encourages teams to draw personalized patterns or words on the flag, which calls for positive content reflecting the competition theme and spirit, without showing words or pictures related to the MakeX Robotics Competition Committee.

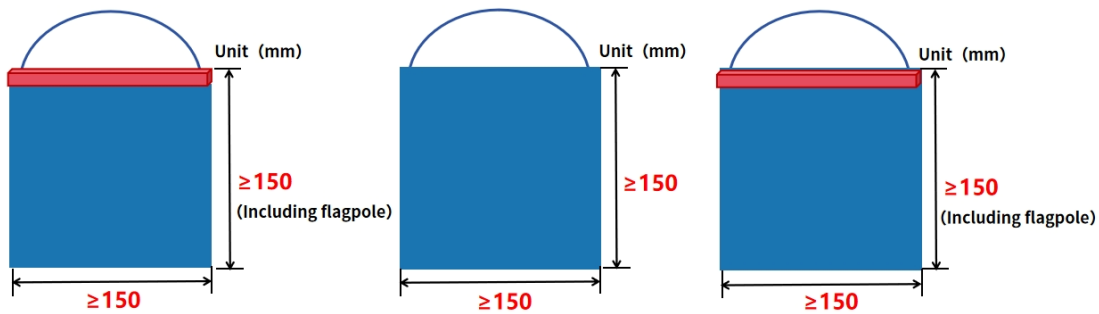

Fig 4.3-3 Netflix flag

Robot

The robots are made by the team itself. Each team is only allowed to use one robot.

The team flag must consist of a flag surface and suspension components, and the flag structure must follow the regular flag shape, with no irregular flag shapes permitted, as shown in diagrams 4.3-3.

Throughout the competition, teams are only allowed to contact with the robot at the beginning of the automatic stage and when applying for flag loading in the manual stage; otherwise, the robot will be treated as a scoring prop in the arena, and teams are not allowed to contact with the robot directly or indirectly at any time. Please refer to "5.1 Robot General Specifications" for robot building specifications.

* Note: All areas and props have certain tolerances. If there are any objections to the size of the props or other problems, the referee can determine whether to change them according to the actual situation.

4.4 Missions Introduction and Scoring State Judgement

The competition spans 4 minutes, comprising an automatic stage (30 seconds) and a manual stage (3 minutes 30 seconds). Each stage includes specific missions, detailed below. Contestants will be alerted to the commencement and conclusion of each stage by the referee's countdown. For a comprehensive understanding of the sequence of events, please refer to "4.6 Single Match Flow".



Stage and Time	Missions	Mission Details
Automatic Stage (30 seconds)	Collecting Purification Cartridge (Red/Blue ball)	Run the automatic program to collect red or blue balls from both the own camp and the central resource areas, aiming to deposit them into the central basket.
	Creating Network Guardian Barrier (Cone)	Run the automatic program to collect the [yellow cones without dots] in the central resource area and hang them on any of the octagonal pillars in the cone hanging area on your camp.
	Recycling Network Guardian Barrier (Cone)	Run the automatic program to remove the red/blue dot cones from the hanging bars in your side's cone hanging area and place them in the cone placement area in your side's resource area or the cone placement area within the plank in the central resource area.
Manual Stage (210 seconds)	Collecting Purification Cartridge (Red/blue)	Control the robot to collect red or blue balls from both own camp and the central resource areas, to place them into the central basket.
	Creating Network Guardian Barrier (Cone)	Control the robot to collect the [yellow cones without dots] in the central resource area and hang them on any of the octagonal pillars in the cone hanging area on your camp.
	Recycling Network Guardian Barrier (Cone)	Control the robot to remove the red/blue dot cones from the hanging bars in your side's cone hanging area and place them in the cone placement area in your side's resource area or the cone placement area within the plank in the central resource area.
	Hanging Netflix Flag	Control the robot to suspend the team



	(Team flag)	flag in the designated flag-hanging area.
	Upgrading Central Purifier (Robot)	Control the robot, the red and blue sides each hang their robots from suspension poles on the left side of their side of the field.

Mission Name: Collecting Purification Cartridge

Mission Description: This mission can be finished in the automatic and manual stages.

In the automatic stage, the robot shall run the automatic program that collects balls from its own resource area and the central resource area and puts balls of its own color into the central basket by bouncing, tossing, etc.

In the manual stage, the contestant controls the robot, collects balls from their own resource area and the central resource area, and throws balls of their side's color into the central basket by bouncing or throwing them.

Scoring State Judgement: Points are allocated based on the positioning of the balls of the respective color in the central basket at the time of scoring. The outer edge of the ball basket's flat beam serves as the boundary for decision-making.

- a. The vertical projection of the ball is completely in the central basket;
- b. The robot must not make direct contact with any ball within the central basket; otherwise, all balls of the respective color in the central basket are invalid.

All these conditions are met simultaneously, and the corresponding balls will be awarded.

Mission Score: Each ball of respective color that is successfully launched into the central basket counts 20 points.

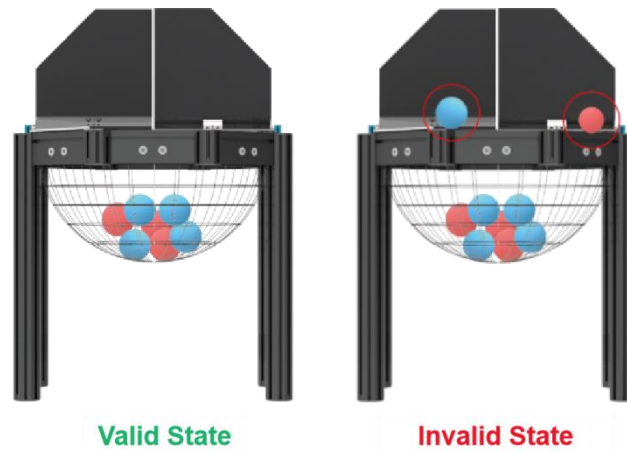

Fig.4.4-1 Scoring State Judgment of balls

Mission Name: Creating Network Guardian Barrier

Mission Description: This mission can be finished in the automatic and manual stages.

During the automatic stage, robots run the pre-set automatic program to collect the yellow cones without dots from the central resource areas and subsequently hang them on any of the octagonal pillars in the cone hanging area in your camp.

In the manual stage, contestants control their robots to collect the yellow cones without dots from the central resource areas and subsequently hang them on any of the octagonal pillars in the cone hanging area in your camp.

Scoring State Judgement: At the scoring time, it can be scored if the vertical projection of the yellow cone without dots entirely within the arena, and the cone base should be oriented downward. The cone must be securely suspended on the octagonal pillar and not in contact with any elements other than the octagonal pillars in their own cone hanging area.

Mission Score: Each successful hanging of a yellow cone without dots counts 40 points.



Fig.4.4-2 Scoring State Judgment of cones

Mission Name: Recycling Network Guardian Barrier

Mission Description: This mission is executable in automatic and manual stages.

During the automatic stage, the robot runs an automatic program to remove the red/blue dotted cones from the octagonal pillars in their side's cone hanging area and place them in the cone placing area in their own resource area or the cone placing area within the board in the central resource area.

During the manual stage, the contestant controls the robot to remove the red/blue dotted cones from the octagonal pillars in their side's cone hanging area and place them in the cone placing area in their own resource area or the cone placing area within the board in the central resource area.

As shown, up to 2 yellow cones with dots of the respective side's color may be placed in their own resource area, and up to 2 yellow cones with dots of the respective color may be placed within the Central Resource Area plank.

Scoring State Judgment: The vertical projection of the red/blue dotted cones shall completely cover the circle of the cone placement area in the own resource area, and the vertical projection of the red/blue dotted cones shall be completely embedded in the cone placement area in the central resource area.



Mission Score: 40 points are awarded for the placement of a dotted cone that is successfully placed.



Fig.4.4-3 Scoring State Judgment of cones

Mission Name: Hanging Netflix Flag

Mission Description: This mission is designated for completion during the manual stage.

During the manual stage, robots may return to the starting area at any time. Each team has only one opportunity to manually load their team flag onto the robot and successfully hang it on the flagpole in the designated flag-hanging area. In a single match, each robot is allowed to carry only one flag into the arena, and each flagpole is designated for one flag only.

Scoring State Judgement: At the scoring moment, the flag must be hanging on the flagpole with the flag surface fully unfolded, meeting the production specifications, and having no contact with any other arena elements to be considered a valid hanging.

Mission Score: Each successfully hanging flag counts 50 points.



Mission Name: Upgrading Central Purifier

Mission Description: This mission is exclusively conducted during the manual stage.

During the manual time, the red and blue sides each suspend their robots from the suspension poles on the left side of their side of the field and meet other specific conditions at the same time to score points.

Scoring State Judgement: At the scoring time, the robot must be fully suspended on the flat aluminum bar of its side's left-hanging pole and remain stationary. Additionally, the robot must not be in contact with any arena elements and props other than the flat aluminum bar of the left-hanging pole to be considered a valid suspension.

a. The robot is in contact only with its side's left hanging pole and does not contact with the arena map or any other arena components.

b. The robot is not in contact with arena props (cones, red/blue balls, flags, and other arena elements), or with its own alliance's robot, or supported by any element (including another robot from its own side, which must not be in contact).

c. At the end of the match time, the robot on the left suspension pole must be stationary. If the robot on the left side of the pole is still in motion (including body shaking, displacement, etc.), the score for that mission is invalid.

Example: On the referee's command, "5, 4, 3, 2, 1, the match is over!" At this point, both teams must immediately put down their Bluetooth controller. At the time of the judge's scoring, the robot has been fully suspended to the left side of the suspension bar but is still in the inertial swing state and has not come to a standstill, so the score of the mission is 0.

If all the above conditions are satisfied, it will be regarded as a valid scoring state.

Mission Score: Each successfully hanging robot counts 100 points.

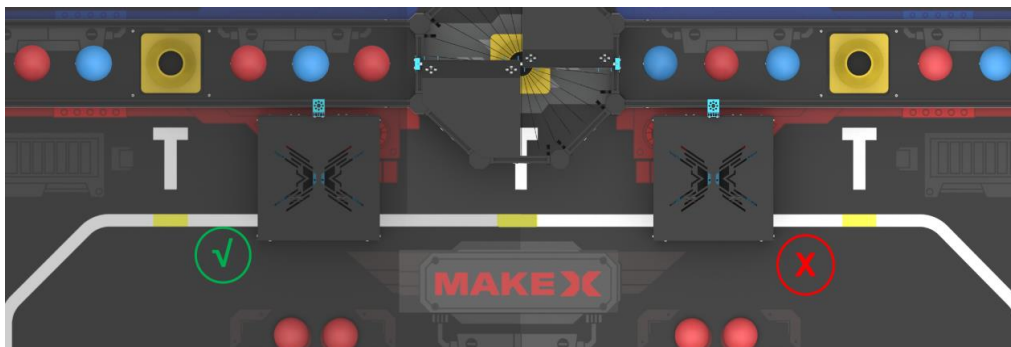

Fig.4.4-4 Scoring State Judgment of Robot Hanging

Boundary State Judgement

During the match, if the position of the robot (or props) relative to the designated boundary is unclear, the following criteria apply for state judgment:



Fig.4.4-5 Boundary state determination

4.5 Scoring Explanation

The final score of the competition is determined by the final static state of the scoring prop after the competition. Competition missions, scoring props and their corresponding points are as follows. After the competition, the referee calculates the sum of the scores of each mission, and the alliance with the higher score will be the winner.

Alliance points of single match = respective color ball points + cone hanging/placing points + team flag hanging points + robot hanging points - penalty points



Mission	Scoring Props	Point of Single Prop	Max. Number of Single Prop	Maximum Mission Point
Collecting Purification Cartridge	Red/blue ball	20 Pts/each	22	440 Points
Creating Network Guardian Barrier Recycling Network Guardian Barrier	Cone	40 Pts/each	7	280 Points
Hanging Netflix Flag	Team Flag	50 Pts/each	2	100 Points
Upgrading Central Purifier	Robot	100 Pts/each	2	200 Points

4.6 Single Match Flow

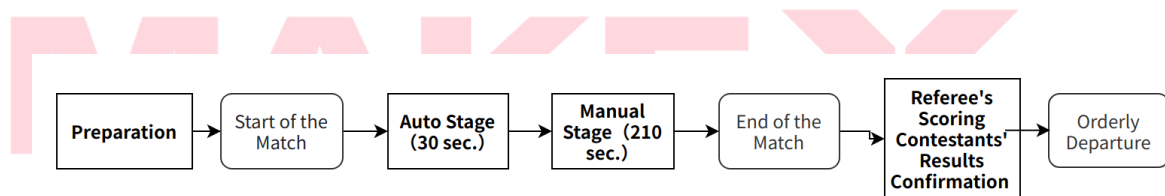

Fig.4.6 Single Match Flow Chart

Preparation

Before the single match, contestants should arrive at the competition area ahead of schedule, and prepare under the guidance of the referee:

- 1) Power on the robot and place it completely in the starting area, with the Bluetooth controller powering on and placing it outside the arena;
- 2) Check the standard of arena and props placement and robot state of both sides;
- 3) Hand up to the referee if all is confirmed, the referee will announce the start of the match.

Automatic Stage

The automatic stage begins after the referee's five-second counting down.



- 1) The contestant is not allowed to contact the robot after running the automatic program.
- 2) Before the end of the automatic stage, robots shall complete the automatic program and remain stationary. Besides, robots do not need to return to the starting area.

The automatic stage ends after the referee's five-second counting down.

Manual Stage

The referee announces, "Contestants, please pick up your Bluetooth controller." At this point, contestants are allowed to pick up the Bluetooth controllers.

The referee announces, "Manual stage, 5, 4, 3, 2, 1, begin!" At this moment, contestants are allowed to control the robot using the Bluetooth controllers.

At any moment during the manual stage, each team has only one opportunity to move the robot out of and back into the arena. During both movements, the vertical projection of the robot must at least partially enter the starting area.

Contestants can request to load the flag onto the robot at any time during the manual stage. To do so, they must shout the command "**Request to Load Flag**" to the referee. Only after obtaining the referee's approval, the contestants can contact the robot. At this point, contestants need to manually load the flag onto the robot. When re-entering the arena, contestants must shout the command "**Request to back to the Match**" to the referee and can proceed with the match only after obtaining the referee's approval. It is important to note that when making requests to the referee, the command must be clear, loud, and concise to avoid delays in the referee's approval.

The referee announces a 5-second countdown, and the manual stage ends. After the manual stage concludes, contestants must immediately put down the blue-tooth controllers and stop controlling the robot.

Referee's Scoring and Contestant's Results Confirmation



The referee will count the scores after the competition. If there is no objection to the competition, the captains of both alliances must confirm the match's result. If there is any doubt about the result, the captain of the alliance may appeal to the referee without signing the score sheet and write down the appeal in the remark column.

After the confirmation of the results, contestants shall actively assist the referee to restore the props and leave the competition area with their robots and Bluetooth controller in an orderly manner.

5. Technical Specifications

5.1 Robot General Specification

The Robot General Specification are prepared for better preparation for teams and ensures a fair and safe competition standard. The committee suggest team to programming and construct the robot under a fully comprehensive understanding of this specification. All robots must follow the Robot General Specification strictly and any against of the requirement will be asked to rectify. The robot might be disqualified if seriously against the specification.

Robot Mechanical Specification

T01. Each team is only allowed to participate in the competition with one robot. It is prohibited for one robot to participate in the match, while the other to conduct construction and modification outside the arena.

T02. Except for the parts like the main board, chassis, wheels and tracks that make the robot move on the flat are non-replaceable, contestants can replace other parts due to parts malfunction or competition mission requests.

T03. During the competition, the maximum extension size of the robot shall not exceed 320mm*320mm*450mm (length * width * height). The maximum extension size refers to the size that the robot extends its mechanic limit during operation. If



the robot is made of a flexible material, the measurements of the maximum extended dimensions of the robot include the dimensions of the flexible material and the flexible material must not be subjected to external forces; flexible materials include but are not limited to, ties, tapes, foam blocks, etc.

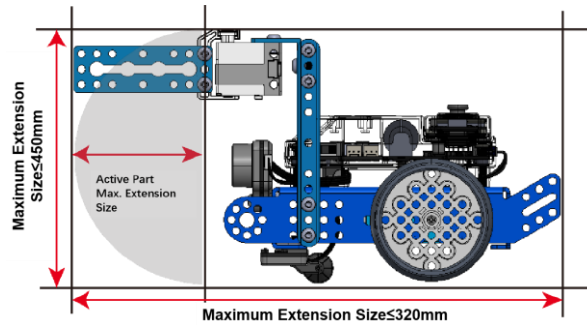

Fig 5.1-1 Maximum Extension Size -Side View

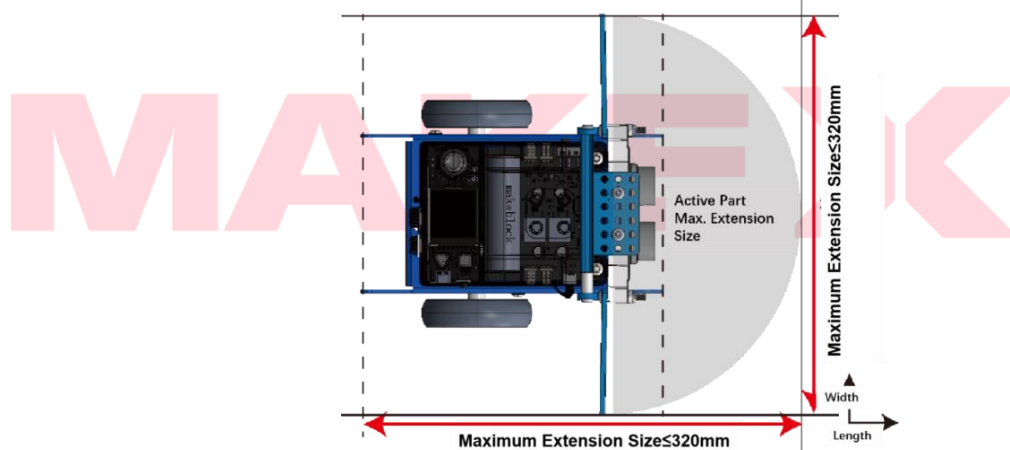

Fig 5.1-2 Maximum Extension Size -Top View

T04. During the competition, the maximum net weight of the robot shall not exceed 6 kg, including the weight of the battery and excluding the weight of the team flag

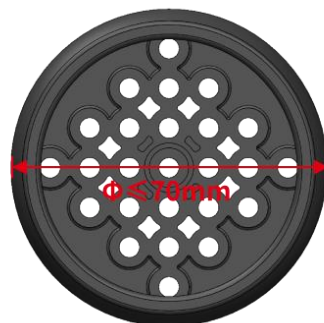

Fig 5.1-3 Wheel Size



T05. To ensure the fairness of the competition, the wheel diameter (including the Rubber tyre skin) must not exceed 70mm.

T06. Equipment with high performance that infringes the competition fairness is prohibited, it must be operated with the following performance indicators:

Equipment	Component	Specification	Note
Motor& Servo	DC motors	1. High-Speed TT Motor <ul style="list-style-type: none"> ● Rated Voltage: DC 6V ● No-load speed: 312RPM±10% ● Gear Ratio: 1:48 2. 37 DC motors <ul style="list-style-type: none"> ● Rated Voltage: 12V ● Rated Speed: 50&200RPM ● Rated Torque: 4.5 kg.cm& 1.5Kg.cm 	<ul style="list-style-type: none"> ● No more than 4 motors (DC motors, encoder motor) are installed on the robot ● No more than 4 servos are installed on the robot ● It is prohibited to alter the internal mechanical structure and electrical layout of any motor or servo, and external welding is permitted without altering the performance of the motor.
	Encoder Motor	Optoelectric Encoder Motor <ul style="list-style-type: none"> ● Driving Voltage: DC 7.4V ● Speed Range: 7.4V0~350RPM±5% ● Rated torque: 800g.cm ● Rotation Accuracy: ≤5° ● Reduction Ratio: 39:43 	
	Servo	MECDS-150 Servo <ul style="list-style-type: none"> ● Working Voltage: DC 6.0V ● Torque Peak: 16.5kg.cm MS-1.5A Servo <ul style="list-style-type: none"> ● Working Voltage: 4.8-6V DC 	



		<ul style="list-style-type: none"> ● Torque: 1.31-.7kg.cm 	
--	--	--	--

T07. To prevent the team from using some high-performance electronic devices to damage the fairness of the competition, the main control electronic devices used by the team should not exceed the following performance indicators:

System	Module	Specification	Note
Power System	Built-in Battery	<ul style="list-style-type: none"> ● 18650 Lithium Battery: 3.7V 2500mAh 	Only one built-in battery and one external battery are allowed, which are required to be securely fastened inside the robot
	External Battery	<ul style="list-style-type: none"> ● 21700 Battery Pack Battery Capacity: 3.7V 8000mAh Discharge Rate: 3C 	
Controlling System	Main-board	<ul style="list-style-type: none"> ● Processor: Highly Integrated ESP32-WROVER-B ● Dominant Frequency: 240MHz ● Working Voltage: 6V ~ 13V (The minimum input voltage of the motor is required to meet the requirement of the motor's working voltage.) ● Communication Ports and Protocols: Serial Port/mBuild Protocol 	Only one main board is allowed

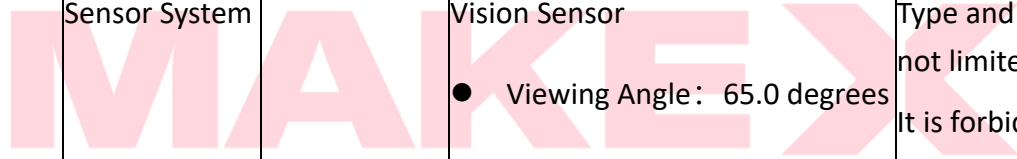

Fig. External Battery Pack

MAKE



	<p>Extension Board</p>	<p>Micro Processor: GD32F403</p> <ul style="list-style-type: none"> ● Input Voltage/Current: 5V 2000mA (Rapid Charging) 5V 500mA (Simultaneous using and charging) ● Communication Mode ● Serial Communication: Main-board to Extension Board ● Digital Signal: Digital Servo Interface ● PWM: DC Motor Interface 	
<p>Sensor System</p>		<p>Vision Sensor</p> <ul style="list-style-type: none"> ● Viewing Angle: 65.0 degrees ● Effective Focal Length: 4.65±5% mm ● Identification Speed: 60 frames/seconds ● Identification Distance: 0.25-1.2m is the best range ● Method of Power Supply: 3.7V Lithium Battery or 5V mBuild Power Module ● Power Consumption Range: 0.9-1.3W <p>Ultrasonic Sensor</p> <ul style="list-style-type: none"> ● Working Voltage: DC 5V ● Distance Range: 5-300cm 	<p>Type and quantity are not limited</p> <p>It is forbidden for robots to use any sensors that will interfere with the perception ability of other robots</p>





		<ul style="list-style-type: none"> ● Tolerance of Distance: $\pm 5\%$ <p>Line Finder Sensor</p> <ul style="list-style-type: none"> ● Working Voltage: DC 5V ● Detected Height: 5mm-15mm 	
Wireless Control System	Bluetooth Controller	<p>Bluetooth Version: Support 4.0+</p> <p>Distance of Remission: 20m</p> <ul style="list-style-type: none"> ● Working Current: $\leq 25\text{mA}$ ● Transmit Power: 4dBm ● Transmit Data: Data packets within 100ms can be acquired by Bluetooth devices (low latency) ● Battery: Two No.5 AA Dry Batteries ● Supported Platform: macOS/Windows 	During the competition, only one Bluetooth controller is available for one team.
	Bluetooth Module	<p>Bluetooth Version: BT4.0</p> <p>Band Range: 2402~2480MHz</p> <p>Antenna Gain: 1.5dBi</p> <p>Energy Consumption Grade: $\leq 4\text{dBm}$</p> <p>Working Current: 15mA</p>	It is forbidden to use any form of wireless control device to communicate with robots other than the official Bluetooth controller, including but not limited to any artificially triggered sensors

T08. Laser sight is not permitted.

T09. Teams are not allowed to build robots using multi-DOF commercial products:

- Including but not limited to multi-DOF manipulator, manipulator, etc.
- Metal and plastic structural parts are not included.



T10. The following robot's parts that may cause danger are forbidden:

- Sharp angle;
- Oil pressure parts or hydraulic parts;
- Switches or contacts containing mercury;
- Parts that will conduct electrical current from robots to the arena;
- Parts that tend to develop connections with other robots, such as hook-shaped parts and other parts;
- Other dangerous parts as determined by the referees.

T11. The following materials that may cause danger are forbidden:

- Flammable and explosive gases;
- Materials containing liquids or gelatinous substances (except for glues and lubricants used in prescribed and small quantities);
- Materials that may cause arena contamination, such as sand, ink, etc.;
- Materials made from animal tissue;
- Materials that may cause danger as determined by other referees.

5.2 Specifications for Netflix Flag

T12. The team flag is a team self-made prop and each team is only allowed to use one team flag. The specifications is as below:

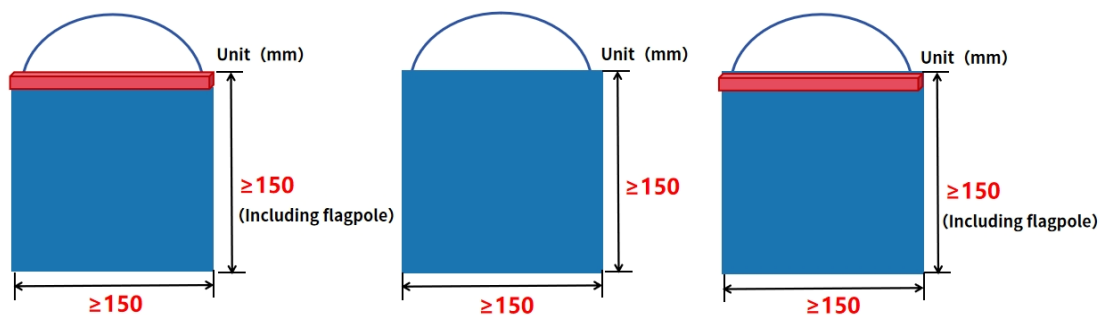

Fig 5.2 Netflix Flag



- The structure and shape of the flag should be referred as the Fig5.2. It must be a regular-shaped flag; Shaped flags cannot be produced and used.
- The team flag must consist of a flag surface and suspension components; a flagpole can be voluntarily added to the suspension components.
- The flag surface material shall be fabric, paper, or other flexible materials, and it must be a rectangular whole flag. Each side must be no less than 150mm in length and cannot be cut or shaped irregularly. The content of the flag must include the "team name," and the team name must be the official name of the participating team. No other team names may be marked or used on the flag.
- The flagpole portion of the suspension components may use rigid materials. If a flagpole is used, it may be made of rigid materials, but the length of the flagpole must be equal to the length of the side it is hanging from, and the cross-sectional dimensions of the flagpole must be smaller than 10mm x 10mm. Irregular flagpoles or additional unusual weights are not allowed, otherwise, the self-made prop will be deemed non-compliant and considered an invalid scoring prop. The overall dimensions must not exceed 200mm (length) x 10mm (width) x 10mm (height).
- Flags can only be allowed to be used in the competition if they meet the rule requirements at any point.
- The committee encourages teams to draw personalized patterns or words on the flag, which calls for positive content reflecting the competition theme and spirit, without showing words or pictures related to the MakeX Robotics Competition Committee.



6. Competition Rules

6.1 Penalty explanation

Suspension

E01. The referee issues a suspension command to ask the team to stop their robot's action. Besides, the referee is entitled to whether to remove the suspended robot from the arena based on specific conditions, including but not limited to robot failure, loss of control, etc.

Violation

E02. The referee issues a violation to the violation team and immediately deducts 20 points. In the meantime, the competition will not pause.

Yellow card

E03. If any contestants' behavior seriously affects the competition fairness or violates the safety rules, the team or alliance will receive a yellow card with 60 points deductions.

Red Card

E04. If any side or its members' behavior seriously affects the competition fairness or violates the safety rules, the alliance will receive 120 points deductions, and the offending team's robot will be suspended.

During the qualification round: take the team as a unit. If one team in the alliance receives a red card, the team will receive a 120-point deduction and the team's robot will be suspended, in the meantime the match will continue as usual. If both teams of the alliance receive a red card, the alliance will receive the points deduction and lose the competition. (If the score of the losing team is higher than the winner, the winner will receive extra points until the final score is 10 points higher than the final score of the losing team)

During the elimination round: take the alliance as a unit. If any team of the alliance



receives a red card, the robots of the alliance will be suspended and the alliance will lose in the match. (If the score of the losing alliance is higher than the winning alliance, the winning alliance will receive extra points until the final score is 10 points higher than the final score of the losing team)

Disqualified from the match

E05. During the match, the team violated the rules, resulting in the invalidation of the score of the match and the robot will be suspended, but did not affect another match.

Disqualified of the entire competition

E06. The robot will be suspended and the team will lose the opportunity to continue to participate in the competition and the right to get an award. Scores of the entire competition will be disqualified.

Penalty Principles at Different Stages

E07. During the qualification rounds, penalties and penalty escalations are handled on a per-team basis. This means that during the qualification rounds, if any team in an alliance receives a violation/yellow card/red card, only that individual team will be subject to the corresponding penalty. The other team in the alliance will still have its separate opportunities for penalties and penalty escalations, and the match will continue.

E08. During the elimination rounds, penalties and penalty escalations are handled on an alliance basis. This means that during the elimination rounds if any team in an alliance receives a violation/yellow card/red card, both teams in that alliance will be subject to the corresponding penalty. However, individual suspension instruction is an exception and is applied on a per-team basis, with penalties and restrictions based on the specific situation.

6.2 Operation Rules

Destructing or Contaminating Arena

R01. If arena contamination is caused by the robot, the robot will be regarded as in



an unsafe state. Robots are not allowed to use double-sided tape, glue or any other materials to fix arena elements during competition.

- The robot that violates the rules will be suspended.

Destructing Other Robots

R02. Robots are not allowed to collide with other robots during competition.

- The robot that violates the rules will be suspended.

Using Banned Materials

R03. The following hazardous materials or dangerous structures embedded in robots are forbidden, such as:

- (1) Flammable gases, fire or smoke generating equipment, hydraulic oil or hydraulic parts, switches or contacts containing liquid mercury (mercury);
 - (2) Hazardous Substances (e.g., Lead);
 - (3) Materials that may cause arena contamination, such as sand and other objects that may be scattered during competition;
 - (4) Materials that may have fixed connections with other robots;
 - (5) Materials with sharp edges that may cause injury.
 - (6) Materials made from animal tissue (for health and legal consideration).
 - (7) Materials containing liquids or gelatinous substances (except for glues and lubricants that are used as required).
 - (8) Parts that can conduct electrical current from robots to any other parts in the arena.
- The robot that violates the rules will be suspended. If the robot would like to continue to be a participant, the team should modify it to pass the re-inspection. A team with two violations will be disqualified entire competition.

Other Unsafe Factors



R04. In addition to R03, referees are entitled to decide whether the robot is safe or not.

- The robot that violates the rules will be suspended. The robot needs to be modified and re-inspected before it can be back to the match. A team with two violations will be disqualified entire competition.

Using Electronic Device or Programming Device

R05. During the competition, it is not allowed for contestants in the competing area to use electronic communication devices (mobile phone, transceiver), it's prohibited to bring a computer, PC tablet or any other programming device into the competing area.

- The offence side shall stop their action immediately. If the offence side refuses to stop their action or sends the devices out of the competing area with the referee's reminder, the team will be disqualified for a single match and not allowed to continue the match, but it will not affect other matches.

Contestants' Requirements

R06. One operator and one observer for each team are allowed to enter the competing area. Each alliance includes two operators and two observers, and one of them is selected to be the captain of the alliance.

R07. It is not allowed for a third person as a substitution for on-arena players. Operators are responsible for controlling the robot in each match. The operator and the observer can freely switch their roles during the match.

R08. Contestants should tie up their long hair during competition preparation, robot debugging and on match. Toe-bearing shoes are forbidden.

- The offence side that violates the rules will be disqualified from a single match and not allowed to continue the match, but it will not affect other matches. The team need to re-adjust and have a re-inspection.



Contestants' Standing Position

R09. During the competition, contestants shall stand in a certain range as shown in the following figure (the size of the operating area is subject to actual conditions).

- The offending team will have 3 seconds to return to their area and the referee will verbally read out the seconds. Teams that fail to return on time will be given a violation. Two violations will result in a yellow card, and three violations will result in a red card and robot suspension.

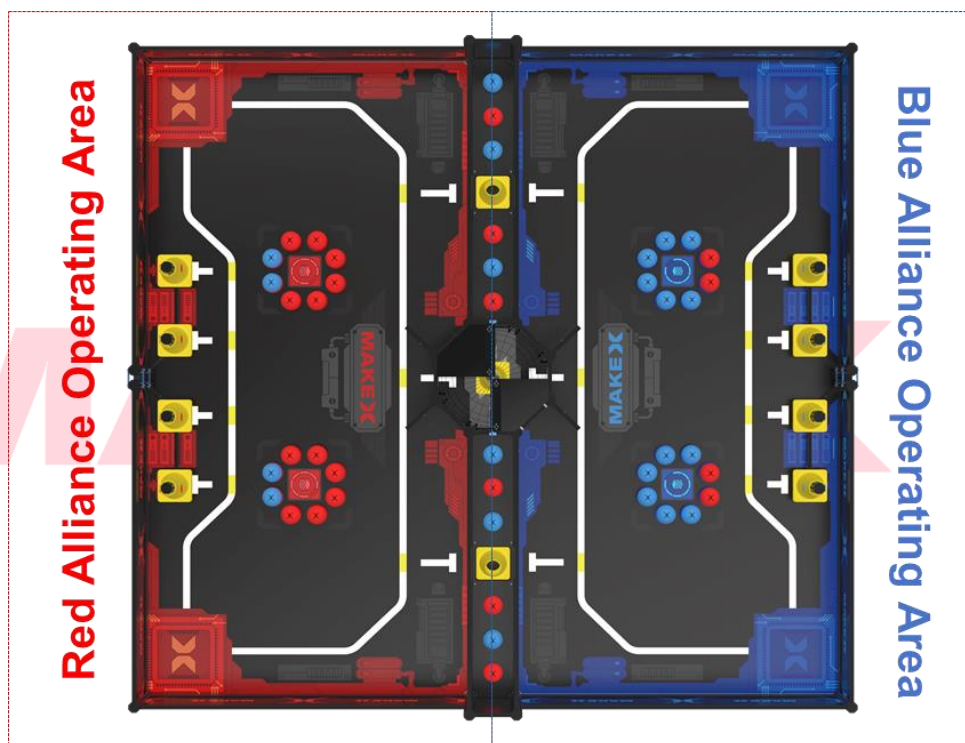

Fig. 6.2-1 Contestant's Standing Position

Rules of Elimination Round

R10. During each BO3 match in the elimination round, after the end of each match, each team has 5 minutes to debug their robot and cannot do overtime.

- A team that violates the rules will be disqualified from a single match and not allowed to continue this single match, but the other matches are unaffected.

Failure to arrive on time at the competing area

R11. Teams shall arrive on time. Teams that do not show up in the competing area



for more than 5 minutes, will be treated as giving up this match voluntarily. If the whole competition schedule is delayed, please refer to the specific notice.

- The offence team will be disqualified from a single match and not allowed to continue the match, but the other matches are unaffected.

Start the match in Advance

R12. Before the referee announces the start of the match in each stage, the robot's chassis must not move, and other structural parts must remain stationary (movement caused by inertia is an exception).

- The violating team will be penalized with a violation; two violations will result in a yellow card, and three violations will directly result in a red card and suspension. Additionally, any scoring advantage gained will be invalidated, the arena should be restored to its original state as much as possible, and the match phase will restart.

Delay the end of the Competition

R13. After the end of the automatic stage and manual stage, the operator shall stop controlling the robot or stop the robot's operation program (except for the motion caused by inertia).

- The offence team will receive a violation. If the delay in ending the competition gives the offending team a scoring advantage, the referee shall judge it as an invalid score and restore the arena to its original condition.

Robots Out of Boundary

R14. Except for the time applied to take out the robot for loading the team flag, the vertical projection of any part of the robot must not exceed the boundary of the arena and the respective robots' active boundary. If the robot is out of bounds, it must return to its own area within 3 seconds, and the referee will give a verbal reminder.

- Failure to return on time will result in a violation, two offences will result in



a yellow card, and three offences will result in a red card and robot suspension.

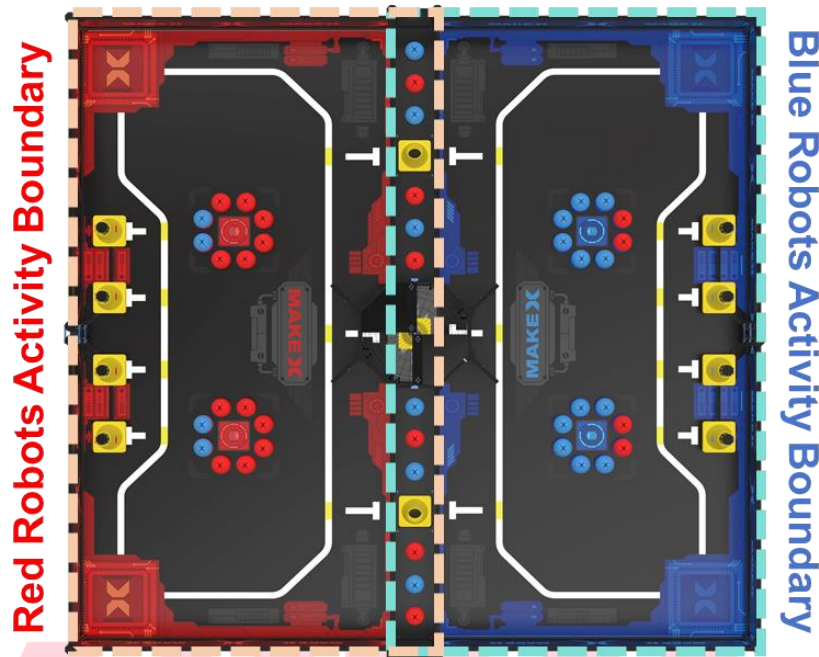

Fig. 6.2-2 Robot Active Boundary

Manipulation violations during the automatic stage

R15. The Bluetooth controller shall be connected to the robot before the match. During the automatic stage, the blue-tooth controller shall be placed outside the arena. The automatic stage adopts the method of "Press the button on the CyberPi to start", and the automatic program operation time must be not over 30 seconds. After the automatic stage, contestants are only allowed to pick up their blue-tooth controller with the referee's command; after the manual stage, contestants must stop controlling their robot immediately.

- If the robot fails to complete the automatic program or remains stationary before the end of the automatic stage, the offending team will be given a violation, and if it generates a scoring advantage, it will be considered invalid and must restore the original state of the arena; except for the non-stationary state due to the inertia of the robot's structure, which will be judged by the actual state of the robot's displacement behavior at the end



of the stage.

- If a blue-tooth controller is used or direct contact during the automatic stage, the first-time penalty will be a violation; twice penalties will receive a yellow card and the match will be restarted; triple penalties will receive a red card and the team's robot will be suspended immediately; and if the circumstances are severe, the team will be disqualified for a single match. The referee may decide whether the match needs to be restarted based on actual match conditions.

Operating Suspended Robot

R16. The operator is not allowed to control the robot after the robot is suspended.

- The team will be disqualified for a single match.

Robot's Left-Behind Components

R17. During the competition, robots may not detach (detach means separate from the main robot body and not under control) parts or leave mechanisms at the competition arena, excluding non-structural parts such as screws.

- The offending party will be penalized with a violation, two offences will result in a yellow card, and three offences will result in a red card and robot suspension.

Robot In-conformity during the competition

R18. The size of the robot shall be in the state that is approved by both teams and the referees before the match. After the pre-match preparation phase after entering the competing area is confirmed by a show of hands by both sides, teams can't raise any appeal regarding this reason. Robots must comply with the size, weight and other parameters specifications during the match. Except for those situations that are caused by non-subjective factors, including being hit by opponents' arena element or other external forces, which leads to robots deforming or oversized.

- The offending party will be disqualified for a single match.



Restricting the Movement of Opponent's Robot

R19. During the manual stage, robots are not allowed to prevent the robot of opponents' alliance from moving in all directions or contacting arena elements.

- The offending party shall stop their action within 3 seconds, the referee will give the time reminder. The first-time offence will be penalized with a violation, second-time offences will result in a yellow card, and three-time offences will result in a red card and robot suspension.

Removing Props out of the arena in Violation

R20. During the competition, it is prohibited to intentionally move any arena props directly out of the field. Instances where the prop goes out of the arena due to actions such as being struck or ejected by the opponent will not result in penalties for the offending team. However, if a team's scoring prop goes out of the arena, it will not count towards the team's scored points.

- The offending party will be penalized with a violation for a first-time offence, two-time offences will result in a yellow card, and three offences will result in a red card and robot suspension. At the same time, those props that have been moving out of the arena will be invalid and cannot be reintroduced into the arena.

Infield Throw and Move-in Violation

R21. During the match, it is prohibited to illegally launch objects into the opponent's field. Robots are not allowed to throw or move unauthorized field elements (such as cones, robot parts, flags, etc.) from their own field into the opponent's field or the central basket.

- Violating this rule will result in a penalty. The first-time violation will result in a penalty, the second-time violation will incur a yellow card, and the third-time violation will lead to a red card and robot suspension.
- Simultaneously, props that illegally moved into the central basket become



invalid. The vertical projection of the props partially into the central basket is used as the criterion for judging. The referee may pause the match based on the actual situation, remove the violated placed prop from the central basket, attempt to restore the original state of the central basket, and then resume the match. Props that are removed from the arena will lose their scoring validity, and any advantage gained through this action is nullified. These props cannot be reintroduced into the arena.

Robots move out the props in the central basket in violation

R22. During the competition, it is prohibited for robots to remove scoring props that have entered the central basket. Simultaneously, the referee may pause the match based on the actual situation, attempt to restore the original state of the central ball basket, and then resume the match. Any advantage gained by the offending team through this action becomes invalid.

- The first penalty will result in a violation, the second penalty will incur a yellow card, and the third penalty will lead to a red card and disqualification.

Robot contact the central basket baffles in violation

R23. Throughout the match, robots are prohibited from actively or passively contacting the central basket baffles and must immediately leave the baffles within 3 seconds. The referee may decide whether to pause the match based on the actual situation. If contact with the baffles results in any advantage for the offending team, the arena must be restored to its original state as much as possible.

- If the robot does not leave the baffles within 3 seconds or if the contact behavior has already resulted in any scoring advantage for the team, the offending team will be penalized with a violation for the first offence, a yellow card for the second offence, and a red card for the third offence, together with the robot suspension. Additionally, any scoring props affected by the violation will become invalid, and the invalid scoring props must be removed from the arena and cannot be reintroduced.



Contestant Contact in violation

R24. Violated Contact with the Robot: Throughout the match, contestants are only allowed to contact the robot at the start of the automatic stage and when applying to load the team flag during the manual stage. At any other time, contestants are prohibited from directly or indirectly contacting the robot.

R25. Violated Contact with any Arena Elements: Based on the principle of "Violated Contact with the Robot," contestants are only allowed to directly contact the robot and the team flag during approved loading time and they are prohibited from directly or indirectly contacting any other scoring props. Throughout the rest of the match, contestants must not directly or indirectly contact any arena elements or scoring props. Scoring props include five items: red balls, blue balls, cones, the team flag and robots. At the end of the match, contestants must immediately put down the Bluetooth controller and take a step back from the arena, without directly or indirectly contacting any arena elements, such as the arena frame. If any violated contact changes the position of arena elements and affects the score, the referee should declare the score invalid and restore the arena to its original state as much as possible.

- The offending team will be penalized with a violation of the first offence, a yellow card for the second offence, and a red card for the third offence. Additionally, the scoring props involved in the violated contact will immediately become invalid and must be removed from the arena, without the possibility of reintroduction into the match.

Violation Loading and Removal of the Robot

R26. When applying to load the team flag, the robot must partially or completely enter the starting area for referees to approve the flag loading. After loading, the robot must partially or completely enter the starting area to get the referee's approval to start the match. It is prohibited for two robots to return to the "same starting area" at the same time to request a load or request a match. During the



competition, except when loading flags, at no time may the robot be removed from the arena by participants, based on the vertical projection of the robot's bottom surface as the criterion.

- The violated robot will be immediately suspended.

Prohibition of Intentional Interference with the Opponent's Robot Hanging

R27. During the match, it is prohibited to intentionally interfere with the execution of the robot hanging mission, including but not limited to directly or indirectly contacting the opponent's robot that is in the process of hanging or has already completed hanging (robot contact due to inertia after the match timer stops is not considered and will not be penalized).

R28. In the last 10 seconds of the match, robots from both sides are not allowed to maliciously collide with the central resource area, such as repeatedly and forcefully crashing into the arena boundary. The referee will decide based on the actual situation.

- The offending team will be penalized with a red card for the first offence with a 120-point deduction, and the immediate suspension of the offending team's robot.

Mentoring in Violation

R29. No person (including but not limited to the parents or mentors of the team) other than the team members shall enter the competition area by any means, and no instruction shall be given in or outside the competition area in any form.

- The team will receive a violation. Penalties may be upgraded until disqualified for a single match.

Off-Arena Contact

R30. During the competition, contestants are not allowed to have any direct contact with off-arena persons and audiences, including but not limited to the delivery of the parts and Bluetooth controller.

- The offended party will be disqualified for a single match.

Malicious Complaints

R31. In a single match, it is prohibited for contestants to make malicious complaints against the opposing team.

- Malicious complaint: After entering the competing area, if the complaining team confirms the need to raise a complaint with the referee, and the referee verifies and determines that the complained-about team has not committed any actual rule violations, the complaining team will be deemed to have made a malicious complaint.
- The robot of the offending team will be suspended.

7 Appeal and Arbitration

7.1 Results Confirmation

Results Confirmation

When a single match ends, captains of both teams need to confirm the results with the referees and then sign the score sheet. The committee will not accept any appeal of the match after the captains have signed and confirmed the result. If there is an error regarding the points calculation for each item on the paper scoring sheet, it will be corrected and confirmed by the resulting approval staff when checking the results; other result-related issues will not be dealt with, and the signed results will be valid.

Dispute Settlement

If the participants still disagree with the result of the competition and do not agree with the explanation of the referee, they can refuse to sign the result, but the participant must write down the situation in the remarks column of the scoring sheet before leaving. The committee will only deal with appeals related to the reasons stated in the remarks column of the paper scoring sheet.



7.2 Appeal Procedure and Valid Appeal Period

Appeal Procedure

Appeals should be lodged within the “valid appeal period” by the prescribed procedure and follow the civil participation spirit. When a participant of a team disputes the current match and fills in the remarks, he/she must obtain an Appeal Form from the Result Approval Area in the first instance; The captain of the team needs to fill in the Appeal Form and then cooperate with the Arbitration Commission to investigate the actual situation. Both sides will be required to arrive at the designated place if the Arbitration Commission requires. During the investigation, the captain of the appeal team must be present, and only captains or contestants of both teams can be present. The Arbitration Commission has the right to communicate with the appealing party alone, avoiding the mentor, the parents of the contestants, their relatives, or friends. The appellant should express facts clearly and objectively, not over-emotionally.

Valid Appeal Period

Normally, the appeal should be lodged within 30 minutes after the end of every single match. The appellant and the respondent must be present before the time appointed by the referee.

Appeal Response

Normally, the Arbitration Commission responds to the appeal after the end of the competition on the same day or before the start of the competition on the next day.

7.3 Invalid Appeal

Overdue Appeal

Appeals that are not lodged within the "valid appeal period" will be considered invalid and inadmissible. If the appellant fails to be present on time or leaves without any reason during the investigation, the appeal will be considered invalid. If the



respondent fails to be present on time, the Arbitration Commission will directly determine the arbitration result and render it as a final result.

Appellants out of Stipulation

The appellants must be the participating contestant and the appeal of another person is invalid. The Arbitration Committee will caution the offending team if parents, mentors, or other irrelevant persons participate in the arbitration process without the permission of the Arbitration Committee.

- Team or alliance will be disqualified entire competition for multiple invalid warnings.

Vague Appeal's Requests

If the Arbitration Commission is unable to understand the appeal or conduct the normal investigation due to the emotional factor of the appealing party, the team will receive a verbal warning.

The team

- or alliance will be disqualified entire competition for multiple invalid warnings.

Uncivil Appeal

Neither side shall make uncivil behavior nor offensive actions and remarks.

- The team or alliance will be disqualified entire competition for multiple invalid warnings.

7.4 Arbitration Procedure

Arbitration Procedure

The Arbitration Commission consists of the head referee, the arbitration consultant, and the competition technical director. The Arbitration Commission is responsible for accepting the appeals and conducting arbitration investigations, to ensure the smooth progress of the competition and the fairness and justice of the competition



results. The playback videos and photographs of any competition may be inaccurate due to the shooting angle, which is only used as reference but not arbitration evidence.

Arbitration Results

The arbitration results can be divided into “maintaining the original result of the match” or “re-match”, and the two teams shall not appeal again. If the arbitration result is a "re-match", the two teams shall have a re-match according to the time and arena stipulated in the Appeal Form. If either team fails to reach the arena within 5 minutes after the beginning of the match, the team shall be deemed to quit the match.

Additional Remarks

The Arbitration Commission determines the final arbitration result, and neither side shall dispute the result of the appeal anymore.

8. Statement

MakeX Robotics Competition Committee reserves the final interpretation of the *2024-2025 Season MakeX Explorer Digital Pioneer Rules Guide*.

8.1 Rules Explanation

To ensure a fair competition and high-quality competition experience, the MakeX Robotics Competition Committee has the right to update and complement this Rules Guide regularly, and issue and implement the latest version before the competition.

During the competition, all matters not stated in the Rules Guide shall be decided by the referee team.

This Rules Guide is the basis for refereeing, and the referee team has the right to adjudication during the competition.



8.2 Disclaimer

All contestants in the MakeX Robotics Competition shall fully understand that safety is the most important issue for the sustainable development of the MakeX Robotics Competition. To protect the rights and interests of all contestants and organizers, according to relevant laws and regulations, all mentors and contestants registered for the 2024-2025 MakeX Robotics Competition, shall acknowledge and abide by the following safety provisions:

- (1) Contestants shall take adequate safety precautions when constructing the robots, and all parts used for constructing the robots shall be purchased from legal manufacturers.
- (2) Contestants shall ensure that the structural design of the robots takes into account the convenience of the inspection and actively cooperate with the host of the competition.
- (3) When modifying and using the parts with potential safety hazards for the robots, it must conform to the national laws, regulations, and quality & safety standards. Those operations shall be manufactured and operated by persons with relevant professional qualifications.
- (4) During the competition, the teams shall ensure that all the actions such as construction, testing, and preparation will not do harm to their team and other teams, referees, staff, audiences, equipment, and arenas.
- (5) In the process of construction and competition, if any action that may violate the national laws, regulations, or standards occurs, all consequences will be borne by the contestants themselves.

The competition kits and parts sold and provided by the supporter, Shenzhen Makeblock Co., Ltd., shall be used by the instructions. Shenzhen Makeblock Co., Ltd. and MakeX Robotics Competition Committee will not be responsible for any injury or loss of property caused by improper use.



The official language for MakeX is Chinese. English or other language translations are prepared to facilitate the team's preparation process. All documents translated to English are for reference only.

8.3 Copyright Declaration

Shenzhen Makeblock Co., Ltd. reserves the copyright of this Rules Guide. Without the written consent or authorization from Shenzhen Makeblock Co., Ltd, any entity or individual may not reproduce, including but not limited to any network media, electronic media or written media.

MAKE X



Appendix 1. Awards and Annual Points

In the 2024-2025 season, according to the scale of the competition and the number of teams, the competition will be classified into Points Race/Regional Competition, National Competition, International/Intercontinental Competition, and Global Finals. In MakeX Explorer, participating teams can obtain points according to the number of wins, ties and losses in the match, and each team can voluntarily sign up for all kinds of Points Race throughout the season to accumulate the annual points. The accumulation of annual points is based on the Team Number.

In each competition, the annual points that teams can obtain are based on the win-loss points they get for every single match in the qualification round and championship round.

Category	Rounds	Win	Tie	Loss
Points Race/Regional Competition	Qualification	5	2	1
	Elimination (Best of 3)	10	/	2
National Competition	Qualification	10	4	2
	Elimination (Best of 3))	20	/	4
International/Intercontinental Competition	Qualification	15	6	3
	Elimination (Best of 3))	30	/	6

Teams that have won the champion, runner-up, second runner-up and other special awards can obtain additional annual points. For the details of the award list, please refer to the **MakeX Awards Guide**.

Category	Awards	Regional /Points Race	National	International/ Intercontinental
Special Award	Champion	15	30	45
	Runner-up	10	20	30
	Second runner-up	5	10	15



	Innovative Design Award	-	5	10
	Engineering Notebook Award	-	5	10
Comprehensive Award	Outstanding Mentor Award (Personal)	-	-	-
	Promotion Ambassador Award (Group)	-	5	10
	Technology Sharing Award (Group)	-	5	10
	MakeX Spirit Award	-	-	10

For example, team X20000 won the champion in a Points Race, and all the results are shown below.

Qualification Round 1	Qualification Round 2	Qualification Round 3	Qualification Round 4	Annual Points from Qualification=13
Win (5)	Loss (1)	Tie (2)	Win (5)	
Top Eight Battle	Semi-final	Final		Annual Points from Elimination=30
Win (10)	Win (10)	Win (10)		

The total annual points that team X20000 obtains = 13+30+15 = 58.



Appendix 2. Engineering Notebook Guideline

*Instruction:

1. The value of an engineering notebook: It helps the team establish files and record the whole learning process. Therefore, it is necessary to record engineering notebooks during the entire preparation for the competition.

2. Engineering notebook submission: Teams can use online documents or handwriting. No matter which way to use it, each team must submit a paper version onsite.

Paper engineering notebook: As the Challenge & Premier programs require the assessment process, one copy of the paper version shall be submitted by each team to the judges onsite. If there is no assessment process (Starter & Explorer), each team will need to submit one copy of the paper version to the staff at the inspection area. Teams that cannot submit the original engineering notebook should prepare their own copies.

3. An engineering notebook will be required for the evaluation of all technical awards. Please refer to the Competition Guide for the evaluation criteria.

Basic Requirements for Cover

The team's name, team number, and competition program must appear on the cover of the engineering notebook.

Basic Requirements for Contents

1. Clear content

Creating content brings convenience for the judges to review and quickly find the corresponding section.

2. Process records (Required)

Every improvement of the robots should be recorded from prototype design, construction, to the debugging. Keep pictures of all manuscripts, design drawings, calculation processes, circuit diagrams, etc., and insert them into the engineering



notebook in the form of pictures.

- 1) Schedule of robot building progress
- 2) Design inspiration/sketch
- 3) Technical principle (it can be disassembled into different parts)
- 4) Production step by step (with clear pictures)
- 5) Problems encountered and solutions

Examples of problems:

What technical failures did you encounter? Why did you fail? How did you solve the problems finally?

What efforts have you made for the robots? What improvements have been achieved?

Does your project progress schedule go as planned? What accidents or delays have occurred? How to fix it?

Have there been any disputes among the team members and how to settle them in the end?

3. Projects summary

- 1) The structure and function of the project (with pictures and text enclosed)
- 2) The technical innovations of the project
- 3) Competition strategies for scoring and defense

4. Team introduction

- 1) A brief biography of each team member and their role on the team
- 2) Culture displaying (logo, team flag, slogan, posters, T-shirt, etc.)
- 3) Excellent achievements sharing (Stories)

5. Feelings and other things you want to share (optional)

- 1) Achievement in the competition (Technical)
- 2) Growth in the competition (Spiritual)
- 3) Suggestions for competition



Appendix 3. Robot Self-Check Form

MakeX Explorer Digital Pioneer Robot

Self-Check Form

Please follow the requirements of the self-checklist and check the box if your robot meets the requirements. And submit the signed self-checklist during the inspection day. Thanks for your cooperation.

Team Number: _____ Team Name: _____

Mentor Name _____

Actual attended Team Member: _____

1. Basic Information
Robot Mainboard Number: _____ (A 12-bit code consist of numbers and alphabet, please find from the CyberPi) Total quantity of mainboard: 1 <input type="checkbox"/> Yes
Robot Size: Length _____ mm, Wide _____ mm, Height _____ mm. (Robot size should not exceed: length 320mm, width 320mm, height 450mm. Please measure your robot and fill in the maximum extension size)
Robot Wheel Diameter: _____ mm (Should not exceed 70mm)
Robot Weight: _____ kg (Should not exceed 6kg)
Netflix Flag: Length _____ mm, Wide _____ mm (The flag surface must be a rectangular whole flag. Each side must be no less than 150mm in length. The content of the flag must include the "team name,". If a flagpole is used, it may be made of rigid materials, but the length of the flagpole must be equal to the length of the side it is hanging from, and the cross-sectional dimensions of the flagpole must be smaller than 10mm x 10mm. Irregular flagpoles or additional unusual weights are not allowed.)
2. Equipment
Name and quantity of motors (quantity ≤4): Name of quantity of servos (quantity ≤4): The total quantity of motors and servos ≤8 <input type="checkbox"/> Yes Please write down specific names, types and quantities. If non-conventional motors



or servos are used, please provide the relevant parameters according to the requirements of the competition guide.

Quantity of Bluetooth controller is 1 Yes
 Wireless control: Bluetooth version: BT4.0 Yes

Name and parameters of battery: (18650 Lithium-ion, 3.7V 2500mAh) Yes
 External battery:(21700Battery Pack 3.7V 8000mAh 3C) Yes

3. Others

No.	Items	Specific Requirements	Meet Requirement
1	Safety Protection	The robot's structure that may harm people is required to ensure safety protection in the process of robot loading, unloading and transporting.	<input type="checkbox"/> Yes
2	Competition arena Destruction	Competition arena destruction is prohibited in the process of robot loading, unloading and transporting.	<input type="checkbox"/> Yes
3	High-power Equipment	High-power equipment is not available during competition and preparation.	<input type="checkbox"/> Yes
4	Energy Storage Equipment	Please keep safe while using energy storage devices (springs).	<input type="checkbox"/> Yes
5	Banned Material	Robots are not allowed to use the flammable gases, pyrotechnic equipment, hydraulic components, mercury-containing components, exposed hazardous materials, unsafe counterweights, designs that may cause entanglement and competition delays, sharp edges and angles, materials containing liquids or gelatinous substances, and any part that the electric current on the robot may be conducted to the competition area.	<input type="checkbox"/> Yes
6	Personal Safety	Long hairs shall be tied up; contestants are prohibited from wearing toe-bearing shoes to enter the competition area.	<input type="checkbox"/> Yes
7	Sensor	Robots are prohibited from using any sensors that can interfere with the sensory	<input type="checkbox"/> Yes



		capabilities of other robots	
8	Self-made Parts	Teams can use self-made parts by 3D printing or corrugated cardboard, wood, acrylic, Rubber bands, etc. All self-made parts cannot have the producer’s logo.	<input type="checkbox"/> Yes
9	Mechanical Parts	Teams can use self-made mechanical parts by 3D printing or laser cutting. Teams must not use commercial structures with mature design, including but not limited to multi-DOF robotic arms or hands.	<input type="checkbox"/> Yes

Our team has checked our own robot according to the self-check form and has filled in the actual data on this form and submitted it to MakeX Robotics Committee. We promise that we will participate in the competition in the above state and will report any changes in time. During the competition, if the robot does not comply with the requirement or our team uses any in-compliance robot, the competition result will be disqualified and all responsibilities will be taken by the team without objection.

Team Leader/Mentor Signature:

Date:





Appendix 4. MakeX Explorer Eco-Pioneer Score Sheet

MAKE X ROBOTICS COMPETITION

2024-2025 MakeX Explorer Digital Pioneer-Scoring Sheet

Competition Info: Qualification Round / Elimination Round ___ (Arena) No. ___ (Session)

Team Registration	Match Points				Winner
Red Alliance	Red Alliance Score & Quantity		Blue Alliance Score & Quantity		Red Alliance
Team 1 (No.):	100pts/each		Hanging Robot 100points/each	100pts/each	
Team 2 (No.):	50pts/flag		Team Flag 50points/flag	50pts/flag	Blue Alliance
Blue Alliance	20pts/each		Red/Blue ball 20points/each	20pts/each	
Team 1 (No.):	40pts/each		Cone 40points/each	40pts/each	
Team 2 (No.):			Penalty		
			Total Points		
Captain of Red Alliance	Captain of Blue Alliance		Remark		
<i>(Please confirm the scoring results and sign here)</i>	<i>(Please confirm the scoring results and sign here)</i>		<i>(If there's any disagreement about the results, please write down the situation clearly and sign here.)</i>		
Referee Signature	Referee Signature				
<i>(Please confirm the scoring results and sign here)</i>	<i>(Please confirm the scoring results and sign here)</i>				



Appendix 5. Competition Resources

Competition resources include but are not limited to official resources provided by the committee, such as Competition Guide, Equipment Instructions, Rules Videos, etc.

The contestants are obliged to keep abreast of the update of competition resources before the competition, and any problems caused by the contestants' failure to keep abreast of the updates shall be borne by the contestants themselves. All official competition resources will be updated in MakeX Website.

MakeX Robotics Competition Committee will revise and improve the Rules Guide with the progress of the competition and the new version will be announced in MakeX Website. The contestants and mentors can download the latest version in MakeX Website.

MakeX Website Download <https://www.makex.cc/en/information/download>.

MakeX Official Website: <https://www.makex.cc/en>.

Any Feedback & Question Please Sent to:

makex_overseas@makeblock.com



MAKEX

Edited By Makex Robotics Competition Committee

RULES GUIDE

MAKEX EXPLORER

Official Website:
www.makex.cc/en

Email:
makex_overseasa@makeblock.com

 Facebook : Makex